



ROOFSEAL
METAL ROOFING SYSTEMS SINCE 1990

The Ideal Solution for all ventilation & rain drainage needs



FIX-FAS GUTTER SYSTEM
for Residential, Commercial
& Industrial Buildings

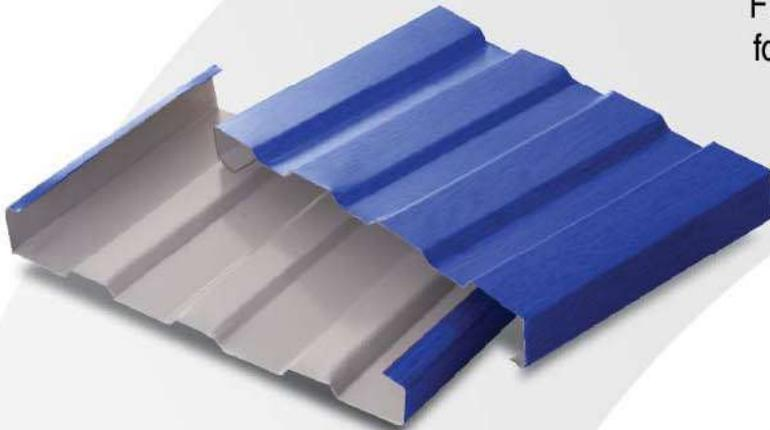

FIX-FAS FASCIA BOARD

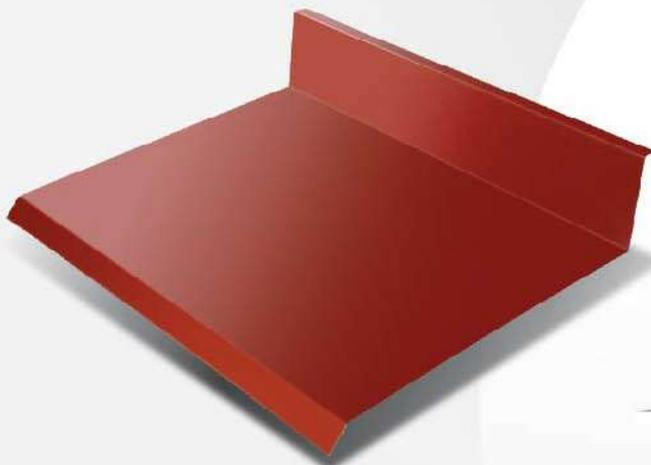

**FIX-FAS FLASHING &
CAPPING SYSTEM**



WHY Fix-fas™ PRESSED STEEL PRODUCTS?

1 STATE-OF-THE-ART MACHINERIES

Our factory uses various ancillary machines and fully staffed modern engineering workshop equipped with computer-controlled (CNC) machineries capable of producing precision parts and tooling for in-house use.

2 LONGEST CONTINUOUS LENGTH IN MARKET

Our product comes in standard lengths of 2440mm, 3050mm and 3660mm or can be custom made up to maximum length of 8000mm continuously without end lapping, thereby minimizing the chances of water leakages at jointing areas.

3 QUALITY STEEL MATERIALS

Our product finishing uses quality metal and they are available in an attractive range of colors including Clean COLORBOND® steel, PRIMA MAJU® steel, ZACS® steel or Prepainted Galvanized steel. Unpainted finishing includes ZINCALUME® steel, Galvanized Iron or stainless steel.

4 CUSTOMIZABLE PRESSED STEEL PRODUCTS

Our pressed steel products can be custom made to suit every design requirements of the market.

Fix-fas™ CUSTOM MADE GUTTER SYSTEM (FOR INDUSTRIAL BUILDINGS)

TYPICAL DETAIL OF GUTTER (Not to Scale)

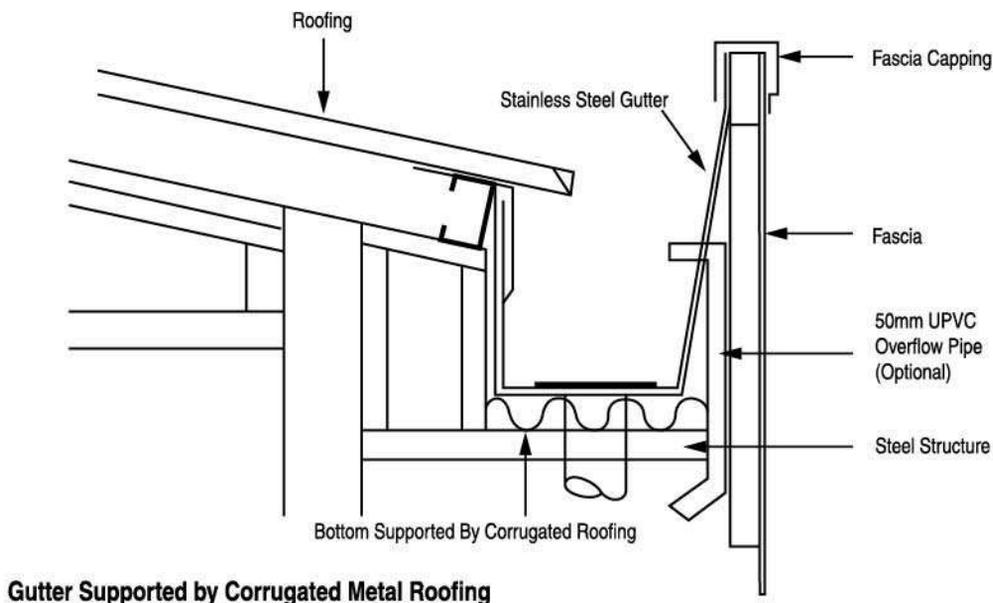
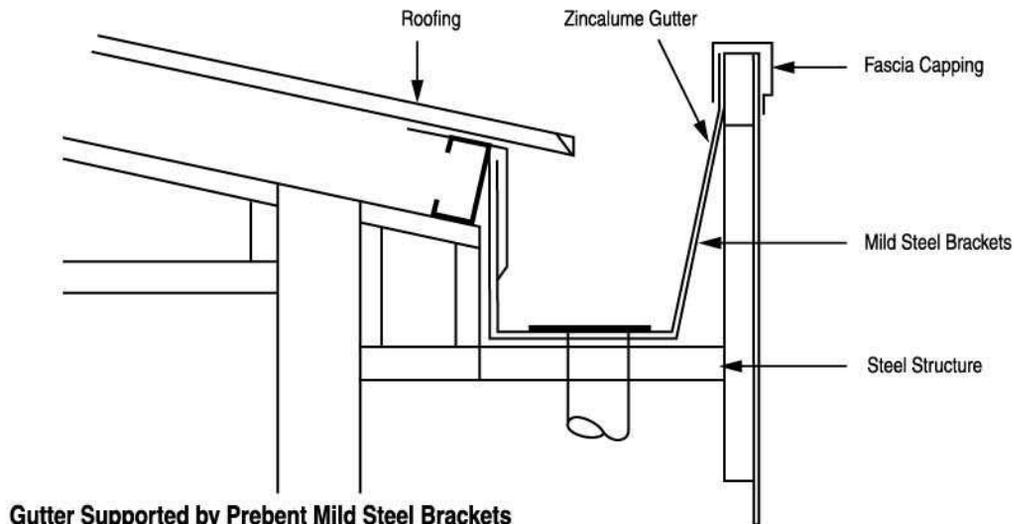

Fix-Fas™ STANDARD EAVES GUTTER (FOR RESIDENTIAL & COMMERCIAL BUILDINGS)

Roofseal offers a range of standard or custom made metal rain gutter that suit your needs. For all gutter profiles, the brackets can be made to be concealed or exposed based on customer's preferences.

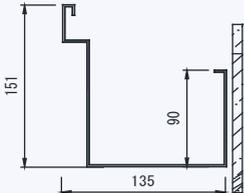
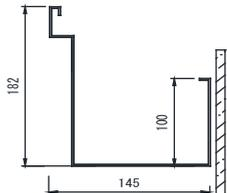
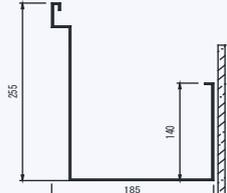
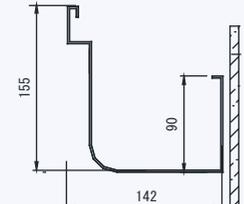
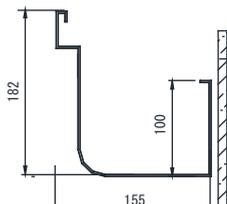
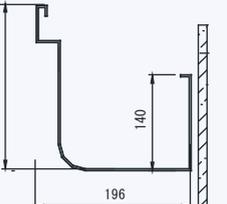
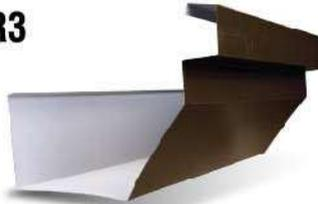
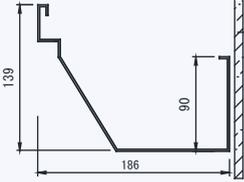
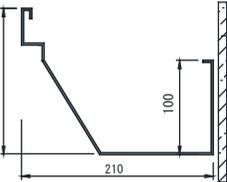
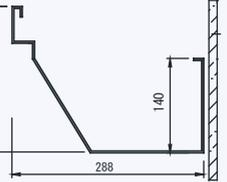
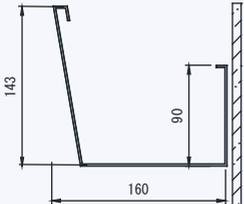
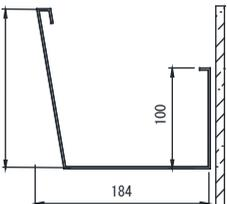
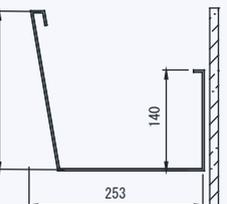
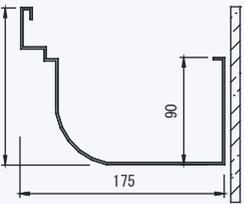
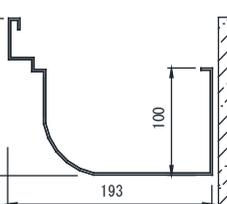
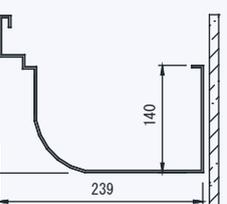
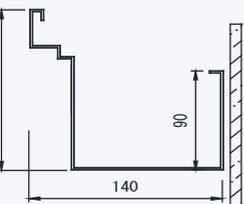
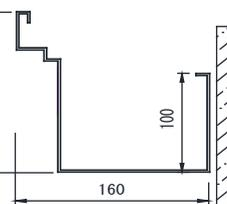
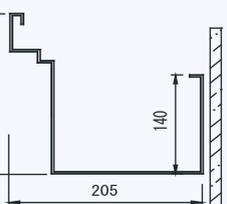
	Type 16 (406mm Girth)	Type 18 (457mm Girth)	Type 24 (610mm Girth)	
R1				
R2				
R3				
R4				
R5				
R6				

INSTALLATION DETAILS

BRACKETS SPACING

When the gutters are attached to **ROOFSEAL FIX-FAS FASCIA BOARD**, then, the gutter bracket spacing should mirror the spacing of the fascia brackets, and the gutter brackets should be adjacent to the fascia brackets. Recommended gutter bracket spacing is 600mm centre to centre.

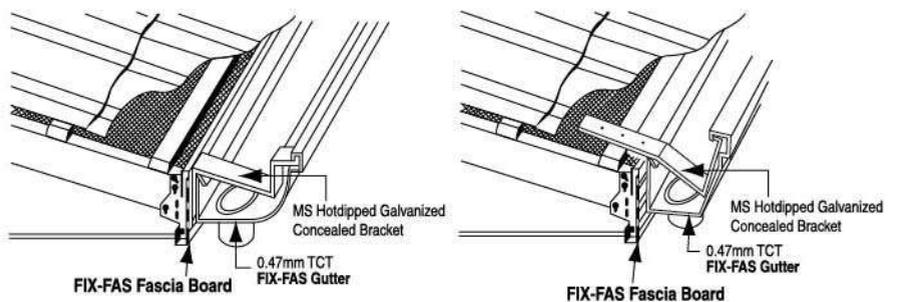

Fix-fas™ FASCIA BOARD

ROOFSEAL FIX-FAS FASCIA BOARD is strong, lightweight, easy to install and can be used as a complete system.

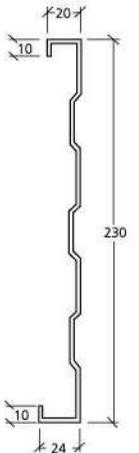
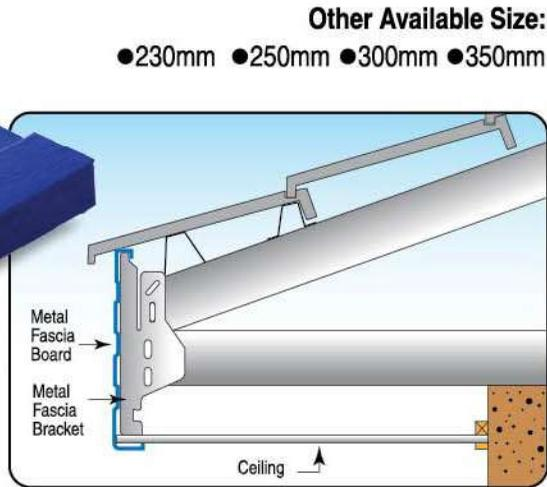

F1 PROFILE	F2 PROFILE
<p style="text-align: center;">TYPE 230</p>	<p style="text-align: center;">TYPE 230</p>
<p style="text-align: center;">TYPE 300</p>	<p style="text-align: center;">TYPE 300</p>
<p style="text-align: center;">TYPE 350</p>	<p style="text-align: center;">TYPE 350</p>

Fix-fas™ STANDARD FLASHING & CAPPING SYSTEM

Roofseal offers standard or custom made flashings or cappings to suit your needs.

RIDGE CAPPING TYPE 24

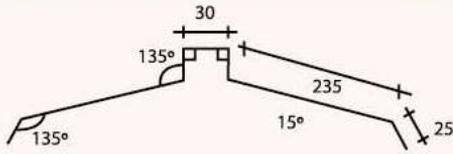

HIP CAPPING TYPE 18

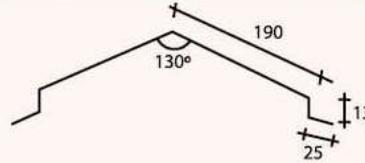

RIDGE CAPPING TYPE 18

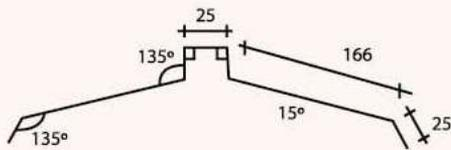

HIP CAPPING TYPE 12

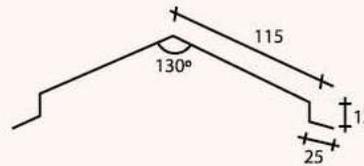

FASCIA/BARGE CAPPING TYPE 18

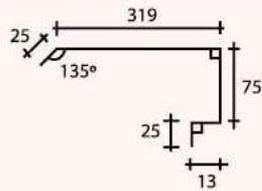

CORNER CAPPING TYPE 9E

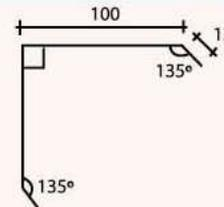

FASCIA/BARGE CAPPING TYPE 12

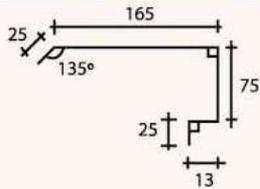

CORNER CAPPING TYPE 9I

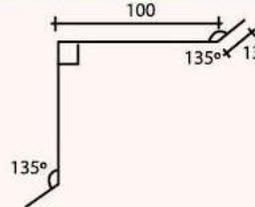

FLASHING TYPE 18

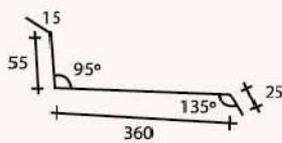

VALLEY GUTTER TYPE 24



FLASHING TYPE 12

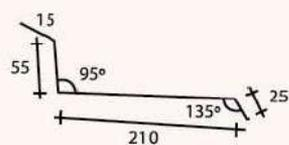

VALLEY GUTTER TYPE 18

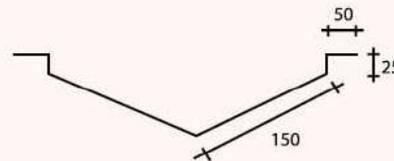

ROOFSEAL

METAL ROOFING SYSTEMS SINCE 1990

PPGi

PREPAINTED GALVANISED IRON

COLOUR CHART - GROUP A



SEMARAK - RED



TELANG - BLUE



KABUS - DARK GREY



MENDUNG - LIGHT GREY



PANDAN - DARK GREEN



LADA PUTIH - BEIGE



ALUZINC

Note : Other colours and thickness available upon request, subject to stock availability and time delivery. All colours shown above are close to the actual steel colour as the limitation of the printing process may affect the actual colour tones

PRIMA[®]

M A J U

COLOUR CHART



PRIMA BIRU



PRIMA DANAU

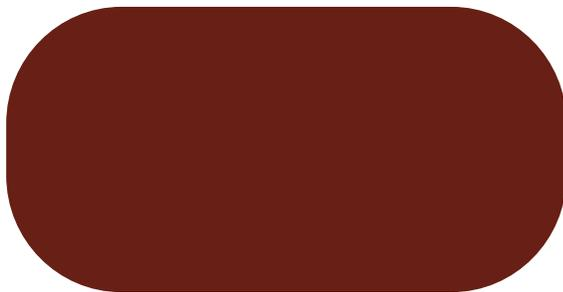

PRIMA MERAH



PRIMA AWANA



PRIMA MAGNET



PRIMA KELULI



Zincalume[®]

Note : Other colours and thickness available upon request, subject to stock availability and time delivery. All colours shown above are close to the actual steel colour as the limitation of the printing process may affect the actual colour tones

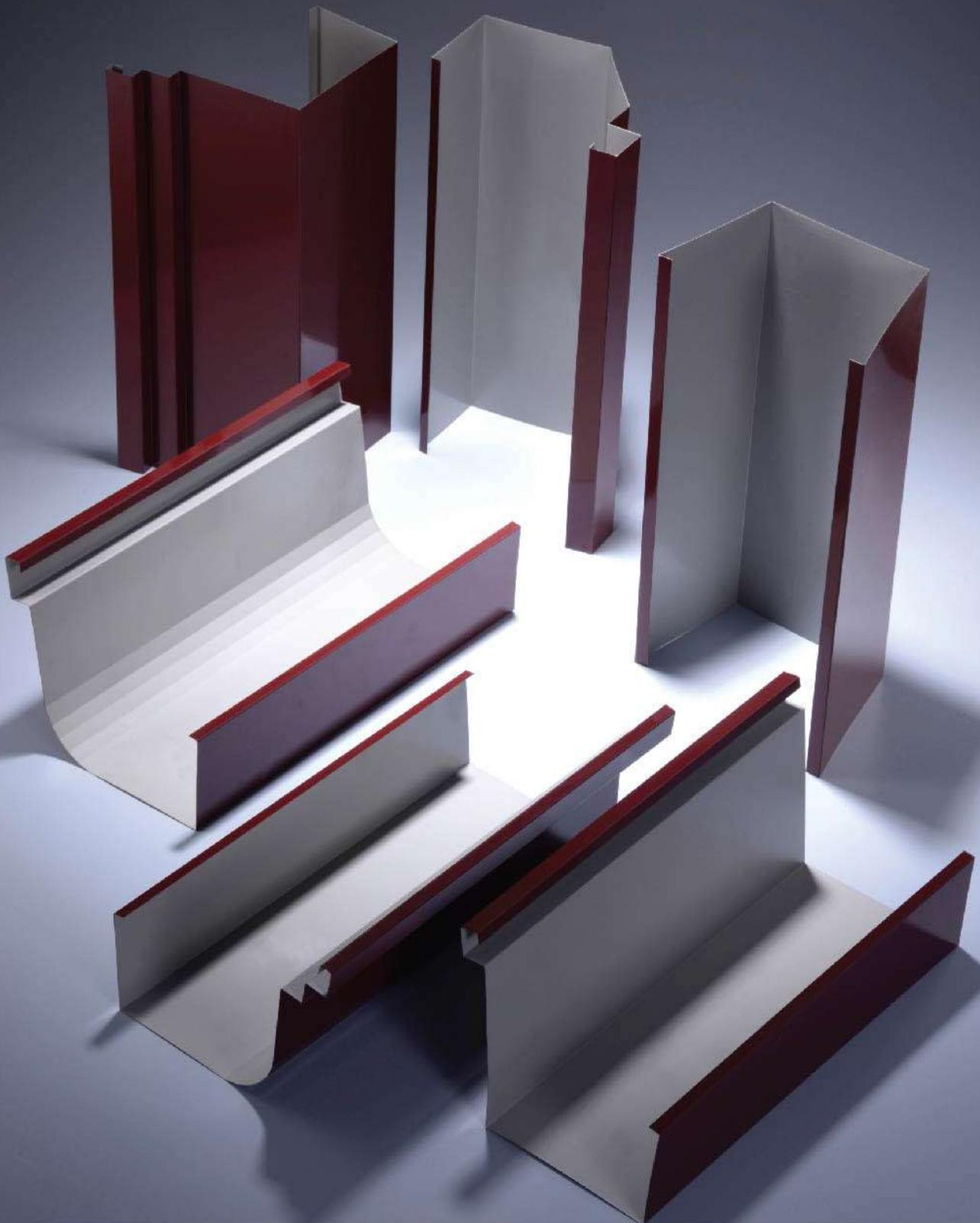

COATING



DESIGN
FLEXIBILITY



RECYCLING



HI-TECH
PRODUCTION



TERMAL
EFFICIENCY



DURABILITY /
SECURITY



COLOUR
CHOICE



WARRANTY

ROOFSEAL
METAL ROOFING SYSTEMS SINCE 1990

Head Office / Showroom

ROOFSEAL RESOURCES (M) SDN BHD (802531-A)

No. 1 & 1-A, Jalan 1/7, Seksyen 1,
Bandar Teknologi Kajang, 43500
Semenyih, Selangor, Malaysia.



Tel : +(6)03 - 8723 4776 (H/Line)
Fax : +(6)03 - 8723 4775

Email : enquiry@roofseal.com.my
Website : www.roofseal.com.my